

SM150T

Soil Moisture Sensor

Quick Start Guide Version 4.0







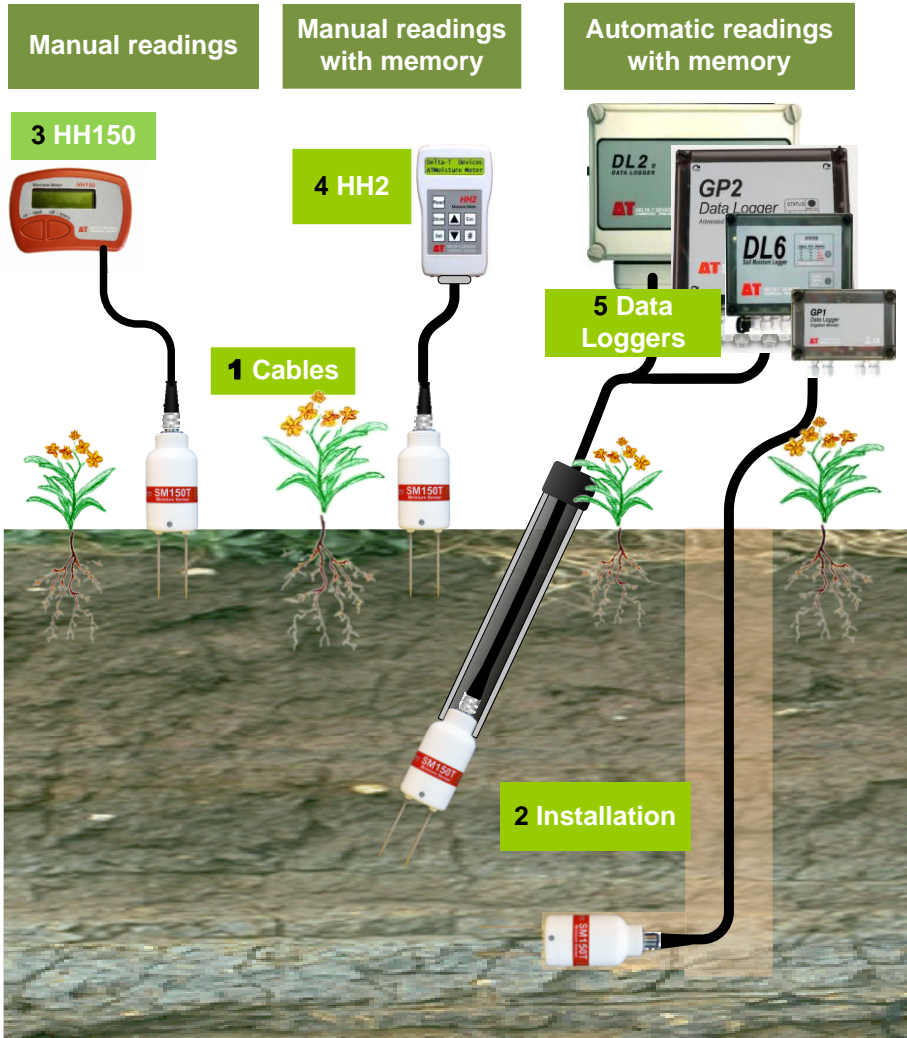



AT Delta-T Devices Ltd

SM150T overview

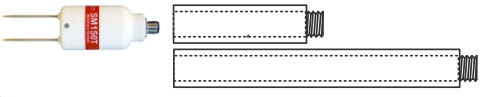

1 Cables and Accessories

	SM150T soil moisture sensor
	SM150T + HH150 Kit
	SM150T + HH2 Kit includes SMSC/d-HH2 cable
	HH150 includes 1m cable, Connects to SM150T
	SMCS/d-HH2 0.9m cable Connects SM150T to HH2
	SMSC/lw-05 5m cable 200mm flying leads Connect to data logger
	Logger extension cables EXT/5W-05 5m EXT/5W-10 10m EXT/5W-25 25m
	Extension tubes ML/EX50 50cm ML/EX100 100cm
	SM-AUG-100 Spiral Auger 1.2m

Logger Extension cables can be joined up to a maximum length of 100m.
Align connectors carefully before pushing parts together.
 Screw together firmly to ensure the connection is water-tight.

Note: HH150 and HH2 meters do not read SM150T temperature.

2 Installation

Surface installation and spot measurements

- Clear away any stones.
Pre-form holes in very hard soils before insertion.
- Push the SM150T into the soil until the rods are fully inserted. Ensure good soil contact.
- If you feel strong resistance when inserting the SM150T, you have probably hit a stone. Stop, and re-insert at a new location.

Note: The SM150T is not suitable for soil surface temperature measurements. For soil temperature near the surface dig a trench and install horizontally as shown below. Cover both SM150T and the first 30cm of cable with at least 5cm of soil.



Installing at depth

- Auger a 45mm diameter hole. $\sim 10^\circ$ to vertical is recommended.
- Fit an extension tube to the SM150T – remember to pass the cable through the extension tube and fit the connector first.
- Push the SM150T into the soil until rods are fully inserted. Ensure good soil contact.



Alternatively

- Dig a trench, and install horizontally.

Note: Extension tubes are available for installing the SM150T in an augered hole.

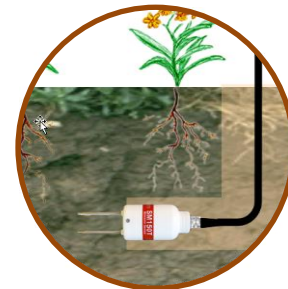

3 HH150 Meter

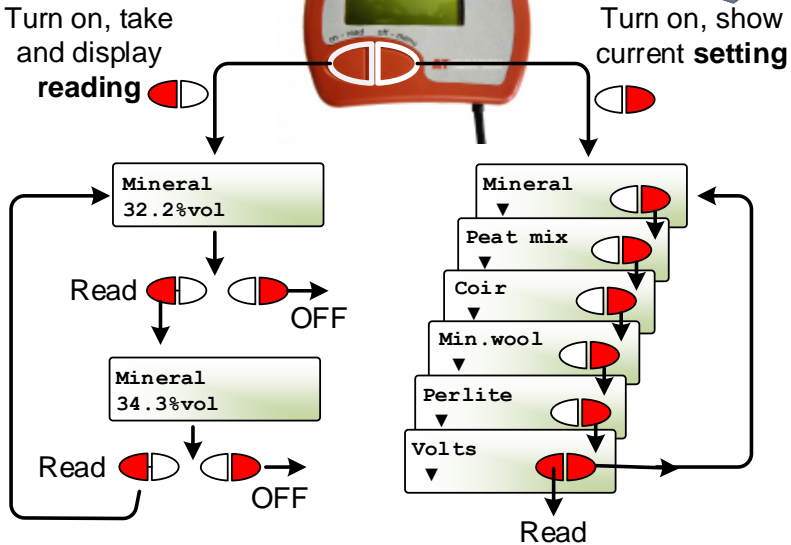

- Connect the SM150T to the HH150 meter.
- With the meter OFF, press the right **off – menu** button. This wakes and allows you to set the meter to display readings - either as % volumetric water content of **Mineral, Peat mix, Coir, Min. wool, Perlite**, or show the sensor output in Volts.
- Press the left **on – read** button to take a reading. Repeat as required. You may wish to write down the readings. The meter will sleep after 30 seconds. The battery should last for about 10,000 readings.

HH150 does not read SM150T temperature

How to Change Battery

Place face down & remove screws

PRESS DOWN

Holding the cable down against the front cover - remove the back

Fit new batteries

Only use good quality alkaline batteries

Replace back cover

4 HH2 Meter

Note the HH2 does not read the temperature sensor.

Use version 2.8 or later of both the PC software HH2Read and the HH2 firmware (see footnote)

- Connect the SM150T to the HH2 meter.
- Press **Esc** to turn the meter on, and if necessary press again until the HH2 displays the start-up screen.
- Set the meter to read from an SM150T:
 - ▶ Press **Set** and scroll down to the **Device** option.
 - ▶ Press **Set** again and scroll down to select SM150T.
 - ▶ Press **Set** to confirm this choice.



Device:
◆ SM150T

- Make sure the HH2 is correctly configured for your soil type:
 - ▶ At the start-up screen, press **Set** and scroll down to the **Soil Type** option.
 - ▶ Press **Set** again and scroll down to the appropriate soil type (use **Mineral** for sand, silt or clay soils or **Organic** for peaty soils)
 - ▶ Press **Set** to confirm this choice.

Soil Type:
◆ Mineral

- Choose the units you want for displaying readings:
 - ▶ At the start-up screen, press **Set** and scroll down to the **Display** option.
 - ▶ Press **Set** again and scroll down to select units.
 - ▶ Press **Set** to confirm this choice.

- Press **Read** to take a reading.
- Press **Store** to save or **Esc** to discard the reading.

SM150T Store?
20.3%vol

- Remove the SM150T from the soil and move to a new location...

- If you have saved data, connect your HH2 to a PC and run **HH2Read** to retrieve the readings.



Note: For an upgrade contact Delta-T.
See also: **HH2 User Manual**

5 Data Loggers

GP2

- 6 SM150Ts can connect to a GP2
12 can be connected if not using the temperature sensors
If using more than 9 you need expansion lid **GP2-G5-LID**.

These details illustrate connection to Channels 1 and 2:

<i>SM150T wiring</i>	<i>Colour</i>	<i>GP2 terminal</i>
Power 0V	brown	CH1 (PGND)
Power V+	white	CH1 (PWR)
Soil Moisture Signal HI	blue	CH1 (+)
Soil Moisture Signal LO	black	CH1 (-)
Cable shield	green	CH1 (PGND)
Thermopile HI	grey	CH2(+) and CH2(-) <i>Fit wire link</i>

Configure channel 1 as type **SM150T** and channel 2 as **SM150T Temperature**.
See also **DeltaLINK*** software sensor **Info Panel** and **Help** or the **GP2 User Manual**.



GP1

- 2 SM150Ts can connect to each GP1. Each SM150T is wired as a differential, powered sensor..

Channel 1 and 3 wiring:

<i>SM150 wiring</i>	<i>Colour</i>	<i>GP1 terminal</i>
Power 0V	brown	CH1 (GND)
Power V+	white	CH1 (PWR)
Signal HI	blue	CH1 (+)
Signal LO	black	CH1 (-)
Cable shield	green	CH1 (GND)
Temperature+	grey	Temp3 (IN)

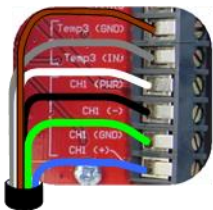

- Using **DeltaLINK*** logger software (version 3.6* or later) configure channel 1 as **SM150T(soil moisture)** and channel 2 as **SM150T(temperature)**.
See also **GP1 Quick Start Guide** and **DeltaLINK Help**.

* Download the latest version of the DeltaLINK logger software, v3.6 or later, from www.delta-t.co.uk or from our **Software and Manuals DVD**

DL6

- Up to 6 SM150Ts can connect to a DL6 logger but only one of the integrated temperature sensors can be connected.
 - Each is wired as a differential, powered sensor.
- These details illustrate connection to channel 6 and 7:

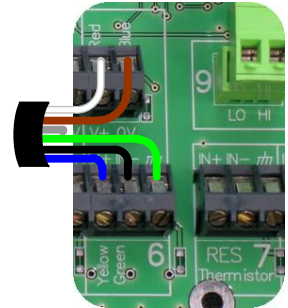

<i>SM150T wiring</i>		<i>Colour</i>	<i>DL6 terminal</i>
Power 0V		brown	0V
Power V+		white	V+
Signal HI		blue	IN+
Signal LO		black	IN-
Temperature +		grey	RES IN+
Cable shield		green	

- In **DeltaLINK** configure channel 1 - 6 as Moisture Probe **SM150T** and channel 7 as **SM150T Temperature**.

See also the **DL6 Quick Start Guide** and the **DeltaLINK** onlin Help.

* Download the latest version (v3.6 or later) of the DeltaLINK logger software from www.delta-t.co.uk or from our **Software and Manuals DVD**.

DL2e

- Up to 30 SM150Ts may be connected (or 60 if not reading the temperature).
- Each soil moisture sensor is connected as a differential, powered sensor.



This example uses channels 57 and 58 with a LAC1 input card configured in 15-channel mode, and warm-up channel 63.

<i>SM150T wiring</i>		<i>Colour</i>	<i>DL2e terminal</i>
Power 0V		brown	CH62- or 61-
Power V+		white	CH63 NO
Signal HI		blue	CH58+
Signal LO		black	CH58-
Cable shield		green	CH61- or 62-
Temperature +		grey	CH57+ and CH57-

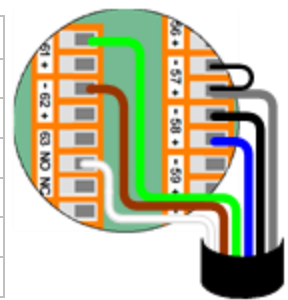

- Configure the DL2e logger channels by selecting the appropriate **SM150T** sensor types from the LS2Win sensor library. Use Ls2Win version 1.0 SR10 or later*.

See also the **DL2e User Manual** or **LS2Win Help**.

* Download the latest version of Ls2Win logger PC software from www.delta-t.co.uk or from our **Software and Manuals DVD**.

6 How to calculate soil moisture

<ul style="list-style-type: none"> ■ Take a reading with the SM150T either ■ Convert the reading to $\sqrt{\varepsilon}$ using equation 1 or the linearisation table below. ■ Then convert $\sqrt{\varepsilon}$ to soil moisture, θ, using the soil calibration values (a_0, a_1). <p>or</p> <ul style="list-style-type: none"> ■ Convert directly for mineral or organic soils using equations 2 or 3 	<p>Example</p> <p>$V = 0.294$ volts</p> <p>$\sqrt{\varepsilon} = 3.52$</p> <p>$\theta = 22.9\%$ for mineral soil</p> <p>$\theta = 22.9\%$</p>
-------------------------------------------------------------------------------------------------------------------------------------------------------------------------------------------------------------------------------------------------------------------------------------------------------------------------------------------------------------------------------------------------------------------------------------------------------------------------------------------------------------	--------------------------------------------------------------------------------------------------------------------------------------------------------------------------------------------------

Conversion to $\sqrt{\varepsilon}$

Polynomial (for use over the full range of SM150T readings)

$$\sqrt{\varepsilon} = 1.0 + 14.4396V - 31.2587V^2 + 49.0575V^3 - 36.5575V^4 + 10.7117V^5 \dots\dots\dots(1)$$

where V is the SM150T output in volts

Linearisation table (for use over the full range of SM150T readings)

V	$\sqrt{\varepsilon}$	V	$\sqrt{\varepsilon}$	V	$\sqrt{\varepsilon}$	V	$\sqrt{\varepsilon}$	V	$\sqrt{\varepsilon}$
0.000	1.000	0.300	3.576	0.600	5.101	0.900	6.778	1.200	8.924
0.075	1.942	0.375	3.964	0.675	5.503	0.975	7.232	1.275	9.743
0.150	2.620	0.450	4.337	0.750	5.917	1.050	7.720	1.350	10.808
0.225	3.144	0.525	4.713	0.825	6.342	1.125	8.270	1.425	12.242

Conversion from $\sqrt{\varepsilon}$ to Soil Moisture

- Soil moisture $\theta = (\sqrt{\varepsilon} - a_0)/a_1$
- Use these generalised soil calibration values for mineral and organic soil types, or carry out a soil-specific calibration to derive your own values See **SM150T User Manual**.
- Multiply x100 to convert soil moisture from $m^3.m^{-3}$ to % volumetric.

	a_0	a_1
Mineral	1.6	8.4
Organic	1.3	7.7
Peat mix	1.16	7.09
Coir	1.16	7.41
Min. wool	1.04	7.58
Perlite	1.06	6.53

Direct conversion for Mineral and Organic soils

$$\theta_{\text{mineral}} = -0.0714 + 1.7190V - 3.7213V^2 + 5.8402V^3 - 4.3521V^4 + 1.2752V^5 \dots (2)$$

$$\theta_{\text{organic}} = -0.0390 + 1.8753V - 4.0596V^2 + 6.3711V^3 - 4.7477V^4 + 1.3911V^5 \dots (3)$$

7 Check Sensor is working

Air reading

- Hold the SM150T in air and away from other objects and take a reading using an HH150 meter, or an HH2 meter or voltmeter or a logger with no more than 5m of cable. In air the reading should be $0 \pm 4\text{mV}$
(Note: the HH150 reports *under-range* if the reading is less than zero)

Warning: Do not touch the pins

Try not to touch the pins. A typical electrostatic discharge from your body can create a temporary offset in sensor readings for up to one hour.



Water reading

- Measure the output in voltage.

In the UK the sensor will typically read about 1.5 volts in tap water (because the salinity is typically $50\text{mS}\cdot\text{m}^{-1}$).

The "water reading" you get will depend on the salinity of your local water.

Note: HH150 meter indicates "TOO WET" above 1.5V or 85% vol.

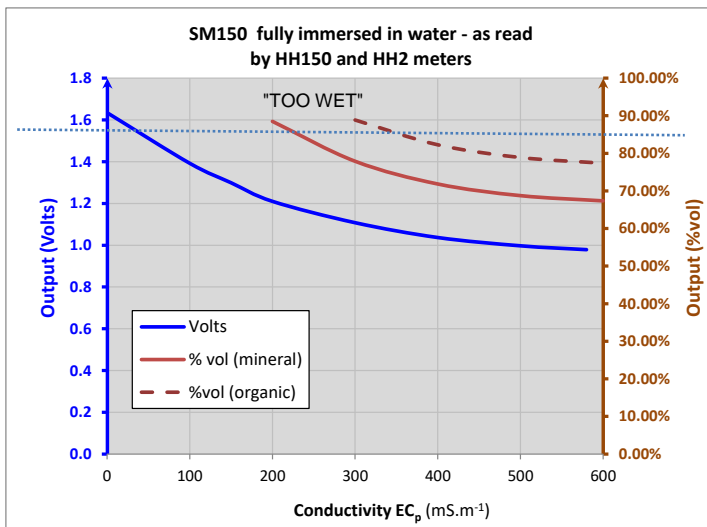

Soil moisture readings are not correct when no soil is present i.e. at 100% vol.

SM150T tables and polynomial constants are optimised at $220\text{mS}\cdot\text{m}^{-1}$ for soil moisture values below 70%vol

Graph: showing the effect of salinity on SM150T sensor output when fully immersed in water with no soil present.

8 Specifications (for full specification see SM150T User Manual)

Volumetric Water Content	
Accuracy	±3.0% vol over 0 to 70 % vol and 0-60°C
Measurement range	0 to 100% vol but less accurate above 70%vol**
Salinity error	±5% vol over 100 to 1000 mS.m ⁻¹ and 0-60% vol
Conductivity response	See SM150T User Manual
Temperature sensitivity	See SM150T User Manual
Sampling volume	See SM150T User Manual
Output signal	0-1 V differential ≈ 0 to 60% nominal
Output compatible with	HH150, HH2, GP1, GP2, DL6, DL2e
Temperature	<i>SM150T must be fully buried to accurately measure soil temperature</i>
Sensor accuracy	±0.5°C over 0-40°C* <i>not including logger or cabling error</i>
Output	Resistance: 5.8kΩ to 28kΩ*
Output compatible with	GP1, GP2, DL6* DL2e
Cabling error contribution (to temperature reading)	0°C for GP1, GP2 & DL6 (any cable length) 0°C for DL2e (with 5m cable).*
Maximum cable length	100m (GP1, GP2 & DL6 data loggers) 100m (DL2e: water content measurement) 25m (DL2e: temperature measurement)
Power requirement	5-14VDC, 18mA for 1s
Operating range	-20 to +60°C
Environment	IP68***
Sample volume	55 x 70 mm diameter
Dimensions	143 x 40 mm diameter
Weight	77 gm (without cable)

HH150 meter	<i>does not read SM150T temperature</i>
Accuracy	±7.5mV (negligible effect on SM150 accuracy)
Resolution	0.1% of volumetric reading or 1mV
Battery / life/standby life	2xGP alkaline AAA/ 10000 readings/1 year
Environmental	Non condensing
Compliance	CE, FCC & ROHS

* Note: See full specification in **SM150T User Manual**

** In water (no soil present) the reading may not be 100% vol.

It depends on a0 and a1 but can still be used as a quick check that the unit is working.

*** With Delta-T supplied cables



Field of sensitivity

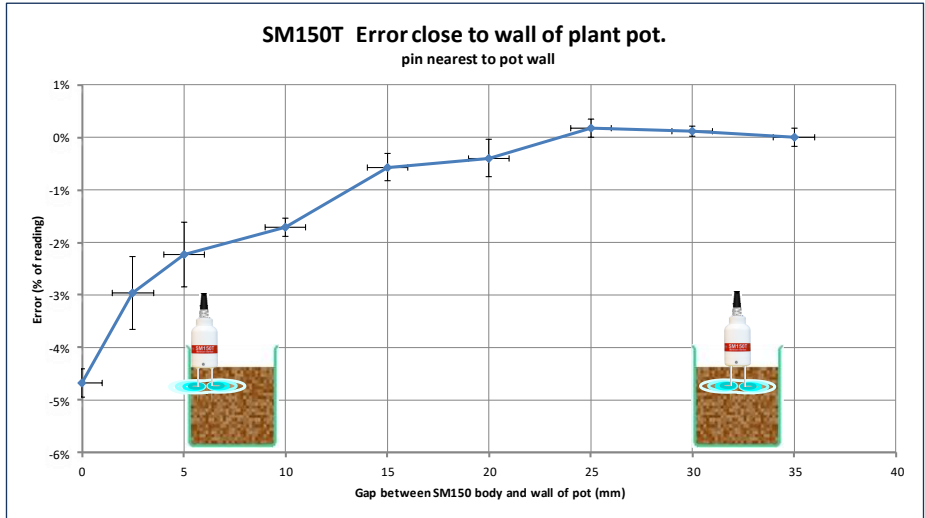

This graph shows the effect of being too close to the wall of a plant pot and gives a partial indication of the shape of the field of sensitivity around the pins

9 Care and Safety

- Do not touch the rods or expose them to other sources of static damage, particularly when powered up.
- Keep the SM150T in its protective tube when not in use.
- Ensure that the connectors are clean, undamaged and properly aligned *before* pushing the parts together. Screw together firmly for water-tight seal.
- Do not pull the sensor out of the soil by its cable.
- If you feel strong resistance when inserting into soil, it is likely you have encountered a stone. Stop pushing and re-insert at a new location.

AT

Delta-T Devices Ltd
130 Low Road
Burwell
Cambridge CB25 0EJ
England (UK)

Tel: +44 1638 742922
Fax: +44 1638 743155
E-mail: sales@delta-t.co.uk
Web: www.delta-t.co.uk